

Two-hand control units

Catalogue no. PD0C98008GB01-ev

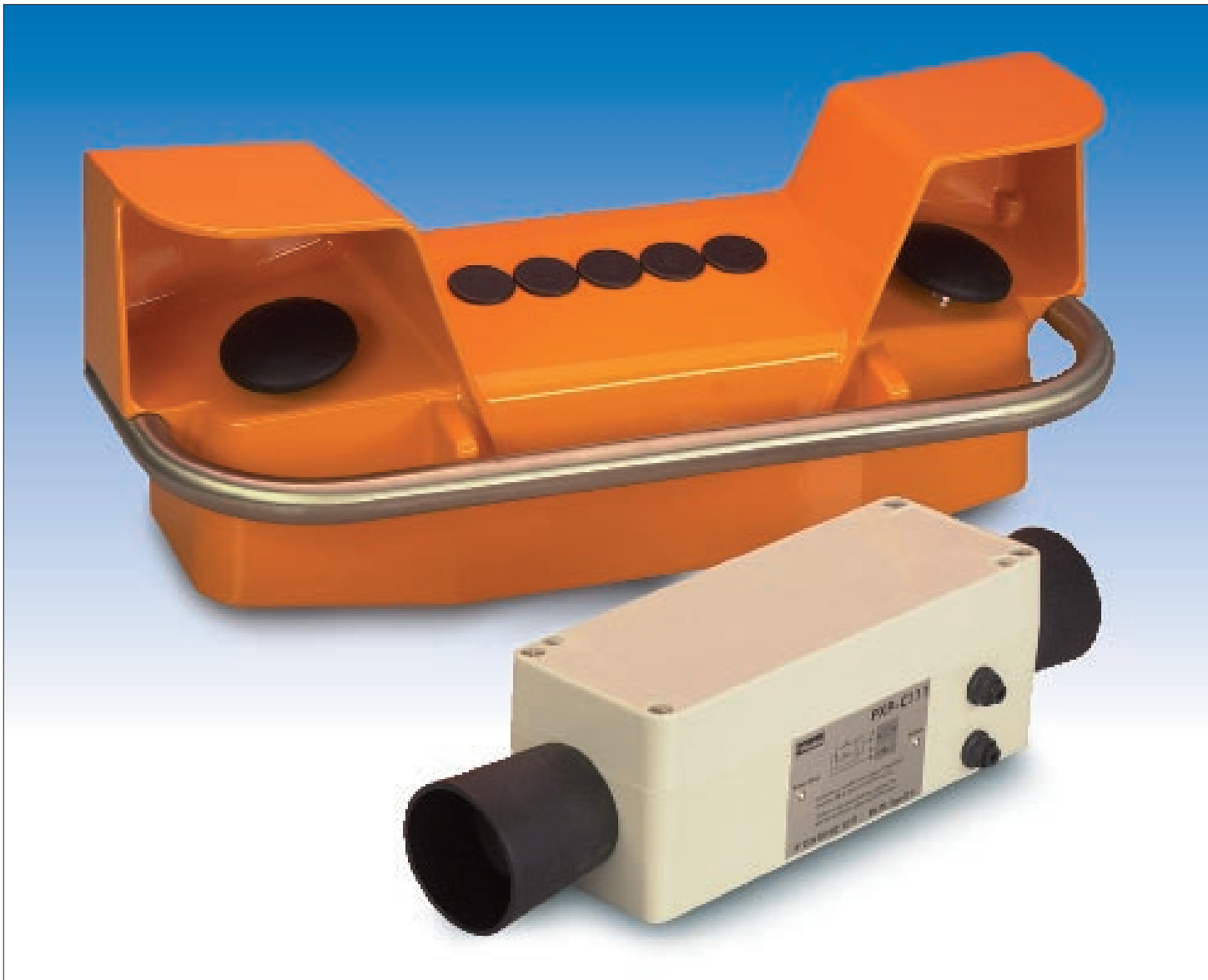

- Ergonomical design
- Robust polymer or metal enclosure
- Meet requirements for protection against accidental operation and tampering
- Metal enclosure features a wrist-rest bar which prevents professional illness due to repetitive actions
- Conform to EN574 and EN954-1 requirements

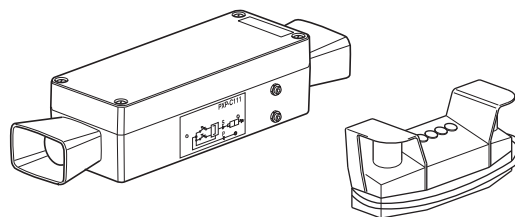

Operating information

Working pressure	3-8 bar
Working temperature	-5 °C to +60 °C

Statutory provisions, European standards

EN 292-1: 1991, Safety of Machinery

Basic terminology, methodology

3.23.4 Two-hand control device.

Hold-to-run control device which requires at least the simultaneous actuation of two manual controls (actuators) in order to trigger and to maintain operation of the machine or machine elements, thus affording a measure of protection for the person operating the manual controls (actuators)

Compliance to standards

Comply with fundamental requirements of health and Safety
European standards Degree 89/392/CEE revised.

Assemblies with type test CE certificates

The following two hand control units are the models which have obtained the type test certificates issued by CETIM

Description Category	Function	Order code	Type test CE certificate				number
Control module	Logic block	PXP-A11	0526	520	4630	03 97	Type III A
Two hand control unit polymer enclosure	Single control	PXP-C111	0526	520	4631	03 97	Type III A
Two hand control unit polymer enclosure	Dual control	PXP-D121	0526	520	4632	03 97	Type III B
Two hand control unit metal enclosure	Single control	PXP-S111	0526	520	4633	06 97	Type III A
Two hand control unit metal enclosure	Dual control	PXP-S121	0526	520	4634	06 97	Type III B

Control module only

Symbol	Connections	Weight Kg	Order code	D
	Ø4 mm Push-in	0,250	PXP-A11*	1

Complete units

Polymer enclosure, with two Ø40 mm push button with protective guards control module(s)

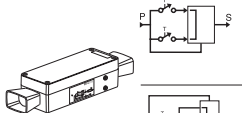
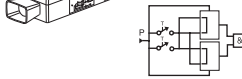
Symbol	Connections	Number of control modules	Weight Kg	Order code	D
	Ø4 mm Push-in	1	1,000	PXP-C111*	1
	Ø4 mm Push-in	2	1,000	PXP-D121*	3

Complete units

Metal enclosure, with two Ø60 push buttons, wrist restbar, built in protective guard and control module(s)

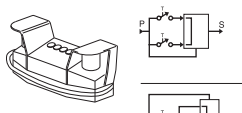
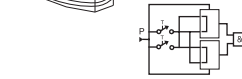
Symbol	Connections	Number of control modules	Weight Kg	Order code	D
	Push-in Ø6 mm for supply Ø4 mm for output	1	4,200	PXP-S111*	1
	Push-in Ø6 mm for supply Ø4 mm for output	2	4,400	PXP-S121*	3

* Language of instruction leaflets

Add suffix to order code as shown below

i.e. **PXP-A11D** = Control Module with a German instruction leaflet

Italian	1
German	D
French	F
English	GB
Swedish	S
Spanish	SP

PXP-A11

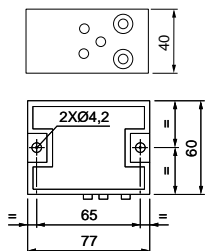

PXP-C111 and PXP-D121

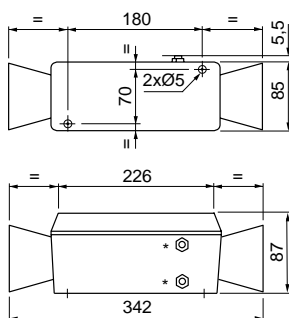

PXP-S111 and PXP-S121

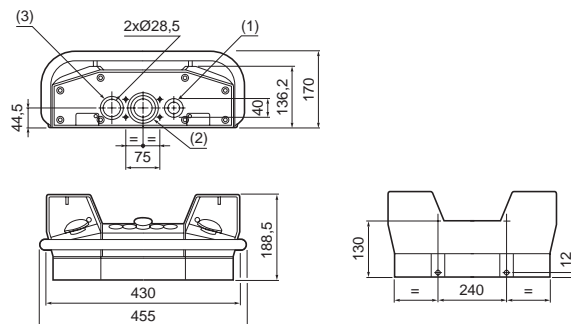

* Ø4 mm push-in connections

** Ø6 mm push-in connections

Pneumatic Division Sales Offices

Cannock - England
Tel: +44 1543 456000
Fax: +44 1543 456001

Prague - Czech Republic
Tel: +42 02 6134 1701
Fax: +42 02 6134 1703

Evreux - France
Tel: +33 232 233400
Fax: +33 232 289807

Ishøj - Denmark
Tel: +45 43 560400
Fax: +45 43 733107

Mettmann - Germany
Tel: +49 2104 137-0
Fax: +49 2104 137-500

Madrid - Spain
Tel: +34 91 675 7300
Fax: +34 91 675 7711

Switzerland
Tel: +41 32 3653711
Fax: +41 32 3653730

Vantaa - Finland
Tel: +358 9 4767 31
Fax: +358 9 4767 3201

Ulricehamn - Sweden
Tel: +46 321 285 00
Fax: +46 321 179 25

Corsico, Milan - Italy
Tel: +39 02 4519 21
Fax: +39 02 4479 340

Brussels - Belgium
Tel: +32 2 762 18 00
Fax: +32 2 762 33 30

Budapest - Hungary
Tel: +36 1 252 8137
Fax: +36 1 252 8129

Langhus - Norway
Tel: +47 64 867760
Fax: +47 64 866888

Oldenzaal - Netherlands
Tel: +31 541 585000
Fax: +31 541 585459

Warsaw - Poland
Tel: +48 22 863 49 42
Fax: +48 22 863 49 44

Austria
Tel: +43 1 892 4545
Fax: +43 1 892 4546



Parker Hannifin plc
Pneumatic Division
Walkmill Lane, Bridgtown,
Cannock, Staffs. WS11 3LR. U.K.

We reserve the right to make
alterations without prior notification.
Edition 01.01